

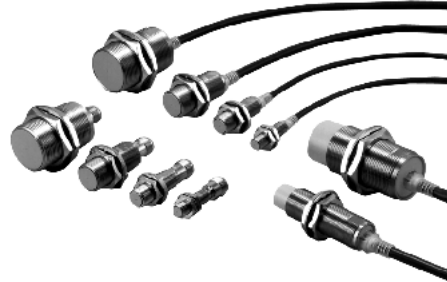







Greater Sensing Distance Offers
Greater Design Flexibility

- Sensing distances approximately 1.5 to 2 times larger than that of any conventional Sensor
- Reduces problems such as the collision of workpieces
- The E2EM has no polarity, thus eliminating problems associated with reversed wiring







Ordering Information



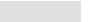

■ DC 2-WIRE/PRE-WIRED MODELS

Type	Size	Sensing distance	Part number	
			NO	NC
Shielded 	M12	 4 mm	E2EM-X4X1	E2EM-X4X2
	M18	 8 mm	E2EM-X8X1	E2EM-X8X2
	M30	 15 mm	E2EM-X15X1	E2EM-X15X2
Unshielded 	M18	 16 mm	E2EM-X16MX1	E2EM-X16MX2
	M30	 30 mm	E2EM-X30MX1	E2EM-X30MX2

■ DC 3-WIRE/PRE-WIRED MODELS

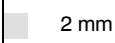
Type	Size	Sensing distance	Output Configuration	Part number	
				NO	NC
Shielded 	M8	 2 mm	NPN	E2EM-X2C1	E2EM-X2C2
			PNP	E2EM-X2B1	E2EM-X2B2
	M12	 4 mm	NPN	E2EM-X4C1	E2EM-X4C2
			PNP	E2EM-X4B1	E2EM-X4B2
	M18	 8 mm	NPN	E2EM-X8C1	E2EM-X8C2
			PNP	E2EM-X8B1	E2EM-X8B2
	M30	 15 mm	NPN	E2EM-X15C1	E2EM-X15C2
			PNP	E2EM-X15B1	E2EM-X15B2

■ DC 3-WIRE/CONNECTOR MODELS

Type	Size	Sensing distance	Output Configuration	Part number	
				NO	NC
Shielded 	M8	 2 mm	NPN	E2EM-X2C1-M1	E2EM-X2C2-M1
			PNP	E2EM-X2B1-M1	E2EM-X2B2-M1
	M12	 4 mm	NPN	E2EM-X4C1-M1	E2EM-X4C2-M1
			PNP	E2EM-X4B1-M1	E2EM-X4B2-M1
	M18	 8 mm	NPN	E2EM-X8C1-M1	E2EM-X8C2-M1
			PNP	E2EM-X8B1-M1	E2EM-X8B2-M1
	M30	 15 mm	NPN	E2EM-X15C1-M1	E2EM-X15C2-M1
			PNP	E2EM-X15B1-M1	E2EM-X15B2-M1

■ ACCESSORIES (ORDER SEPARATELY)

Mounting Brackets

Four kinds of resin mounting brackets are available. Choose an appropriate one depending on external dimensions

Description	Part number	
Mounting brackets	Fits M8 size sensors	Y92E-B8
	Fits M12 size sensors	Y92E-B12
	Fits M18 size sensors	Y92E-B18
	Fits M30 size sensors	Y92E-B30

Note: When using the Mounting Brackets for unshielded models, pay attention to the influence of surrounding metals. (For dimensions of Sensors, refer to the dimensions shown for each model.)

Specifications

■ RATINGS/CHARACTERISTICS

E2EM-X□X□ DC 2-wire Models

Part number	E2EM-X4X□	E2EM-X8X□	E2EM-X16MX□	E2EM-X15X□	E2EM-X30MX□
Size	M12	M18		M30	
Type	Shielded	Shielded	Unshielded	Shielded	Unshielded
Sensing distance	4 mm (0.16 in.) ±10%	8 mm (0.31 in.) ±10%	16 mm (0.63 in.) ±10%	15 mm (0.59 in.) ±10%	30 mm (1.18 in.) ±10%
Supply voltage (operating voltage)	12 to 24 VDC, ripple (p-p): 10% max., (10 to 30 VDC)				
Leakage current	0.8 mA max.				
Sensing object	Ferrous metal (refer to <i>Engineering Data</i> for non-ferrous metal)				
Setting distance	0 to 3.2 mm (0.13 in.)	0 to 6.4 mm (0.25 in.)	0 to 12.8 mm (0.50 in.)	0 to 12 mm (0.47 in.)	0 to 24 mm (0.94 in.)
Standard object (mild steel)	12 x 12 x 1 mm (0.47 x 0.47 x 0.04 in.)	18 x 18 x 1 mm (0.71 x 0.71 x 0.04 in.)	45 x 45 x 1 mm (1.77 x 1.77 x 0.04 in.)	30 x 30 x 1 mm (1.18 x 1.18 x 0.04 in.)	70 x 70 x 1 mm (2.76 x 2.76 x 0.04 in.)
Differential travel	15% max. of sensing distance				
Response frequency	1 kHz	0.5 kHz	0.4 kHz	0.25 kHz	0.1 kHz
Operation (with sensing object approaching)	X1 models: X2 models:	NO NC			
Control output (Switching capacity)	5 to 100 mA				
Circuit protection	Surge absorber, load short-circuit protection				
Indicator	X1 models: X2 models:	Operation indicator (red LED), operation set indicator (green LED) Operation indicator (red LED)			
Ambient temperature	Operating: -25°C to 70°C (-13° to 158°F) with no icing or condensation Storage: -40°C to 85°C (-40° to 185°F) with no icing or condensation				
Ambient humidity	Operating/Storage: 35% to 95% (with no condensation)				
Temperature influence	±15% max. of sensing distance at 23°C (73.4°F) in temp. range of -25°C to 70°C (-13° to 158°F)				
Voltage influence	±1% max. of sensing distance in rated voltage range ±15%				
Residual voltage	5 V max. under load current of 100 mA with cable length of 2 m (78.7 in.)				
Insulation resistance	50 MΩ min. (at 500 VDC) between current carry parts and case				
Dielectric strength	1,000 VAC at 50/60 Hz for 1 min between current carry parts and case				
Vibration resistance	10 to 55 Hz, 1.5-mm (0.06 in.) double amplitude for 2 hours each in X, Y, and Z directions				
Shock resistance	1,000 m/s ² for (3280.8 ft/s ²) 10 times each in X, Y, and Z directions				
Degree of protection	IEC60529 IP67				
Connection method	Pre-wired models standard length: 2 m (78.7 in.)				
Weight (packaged)	Approx. 60 g (0.13 lbs)	Approx. 130 g (0.28 lbs)	Approx. 150 g (0.33 lbs)	Approx. 180 g (0.39 lbs)	Approx. 210 g (0.46 lbs)
Material	Case	Brass			
	Sensing surface	PBT			

E2EM-X□B□/C□ DC 3-wire Models

Part number	E2EM-X2B□/C□		E2EM-X4B□/C□		E2EM-X8B□/C□		E2EM-X15B□/C□		
Size	M8		M12		M18		M30		
Type	Shielded								
Sensing distance	2 mm (0.08 in) ±10%		4 mm (0.16 in) ±10%		8 mm (0.31 in) ±10%		15 mm (0.59 in) ±10%		
Supply voltage (operating voltage range) (see note 1)	12 to 24 VDC, ripple (p-p): 10% max., (10 to 40 VDC)								
Leakage current	13 mA max.								
Sensing object	Ferrous metal (refer to <i>Engineering Data</i> for non-ferrous metal)								
Setting distance	0 to 1.6 mm (0 to 0.06 in)		0 to 3.2 mm (0 to 0.13 in)		0 to 6.4 mm (0 to 0.25 in)		0 to 12 mm (0 to 0.47 in)		
Standard object (mild steel)	8 x 8 x 1 mm (0.31 x 0.31 x 0.04 in)		12 x 12 x 1 mm (0.47 x 0.47 x 0.04 in)		18 x 18 x 1 mm (0.71 x 0.71 x 0.04 in)		30 x 30 x 1 mm (1.18 x 1.18 x 0.04 in)		
Differential travel	10% max. of sensing distance								
Response frequency (see note 2)	1.5 kHz		0.5 kHz		0.3 kHz		0.1 kHz		
Operation (with sensing object approaching)	B1, C1 models: NO B2, C2 models: NC								
Control output Switching capacity (see note 1)	200 mA max.								
Circuit protection	Reverse connection protection, surge absorber, load short-circuit protection								
Indicator	Operation indicator (Yellow LED)								
Ambient temperature (see note 2)	Operating/Storage: -40°C to 85°C (-40° to 185°F) with no icing or condensation						Operating: -25°C to 70°C (-13° to 158°F) Storage: -40°C to 85°C (-40° to 185°F) (with no icing or condensation)		
Ambient humidity	Operating/Storage: 35% to 95% (with no condensation)								
Temperature influence	±15% max. of sensing distance at 23°C (73.4°F) within temperature range of -40°C to 85°C (-40° to 185°F) ±10% max. of sensing distance at 23°C (73.4°F) within temperature range of -25°C to 70°C (-13° to 158°F)						±15% max. of sensing distance at 23°C (73.4°F) within temperature range of -25°C to 70°C (-13° to 158°F)		
Voltage influence	±1% max. of sensing distance in rated voltage range ±15%								
Residual voltage	2 V max. under load current of 200 mA with cable length of 2 m (78.7 in)								
Insulation resistance	50 MΩ min. (at 500 VDC) between current carry parts and case								
Dielectric strength	1,000 VAC at 50/60 Hz for 1 min between current carry parts and case								
Vibration resistance	10 to 55 Hz, 1.5-mm (0.06 in) double amplitude for 2 hours each in X, Y, and Z directions								
Shock resistance	500 m/s ² (1640 ft/s ²) for 10 times each in X, Y, and Z directions		1,000 m/s ² (3280 ft/s ²) for 10 times each in X, Y, and Z directions						
Degree of protection	IEC60529 IP67								
Connection method	Pre-wired models standard length: 2 m (78.7 in) Connector models ("M1" models)								
Weight (packaged)	Pre-wired	Approx. 55 g (0.12 lbs)		Approx. 65 g (0.14 lbs)		Approx. 140 g (0.31 lbs)		Approx. 190 g (0.42 lbs.)	
	Connector	Approx. 10 g (0.02 lbs.)		Approx. 20 g (0.04 lbs.)		Approx. 40 g (0.09 lbs.)		Approx. 90 g (0.20 lbs.)	
Material	Case	Stainless steel (SUS303)		Brass					
	Sensing surface	PBT							

Note: 1. When using the M8 models within the temperature range from 70°C to 85°C, (158° to 185°F) the voltage range must be from 10 to 30 VDC and control output (switching capacity) must be 100 mA max.

2. The response frequency of the DC switch section is an average value.

Engineering Data

OPERATING RANGE (TYPICAL)

Unshielded Models

E2EM-X□MX□

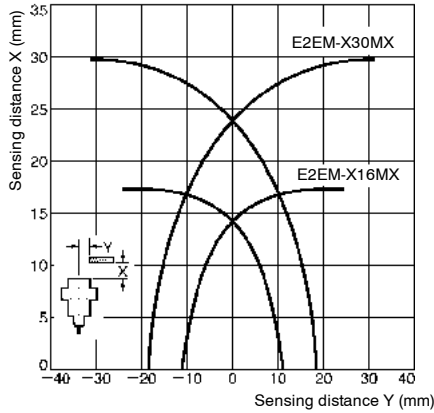

Shielded Models

E2EM-X□X□

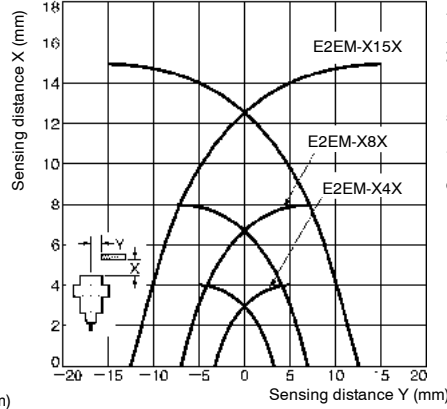

E2EM-XB□/C□

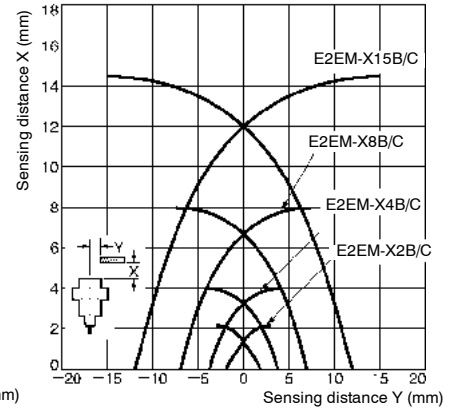

INFLUENCE OF SENSING OBJECT SIZE AND MATERIALS

E2EM-X2□□

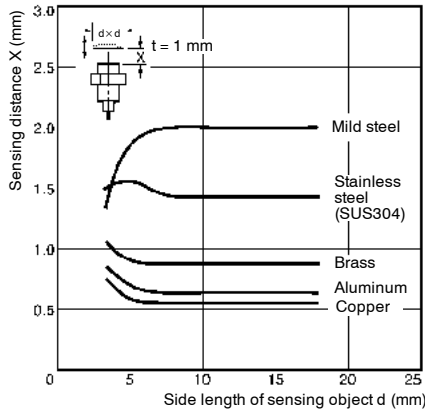

E2EM-X4□□

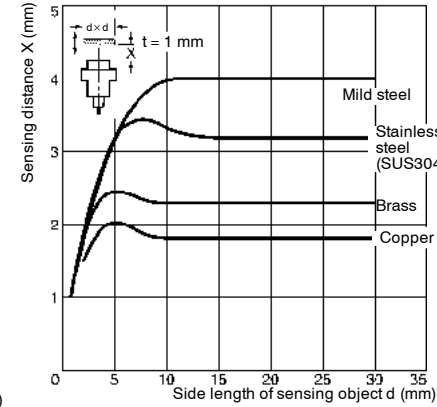

E2EM-X8□□

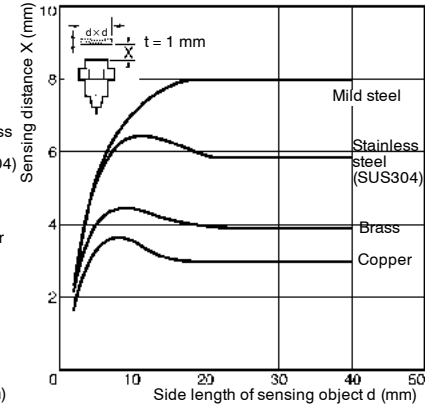

E2EM-X15□□

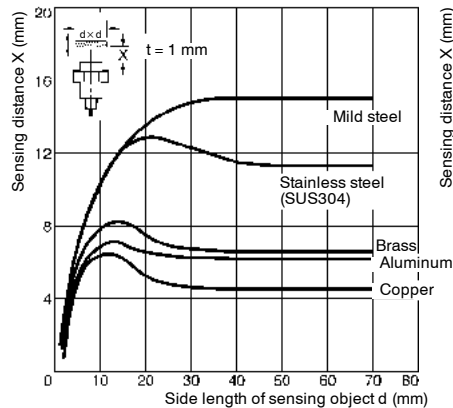

E2EM-X16MX□

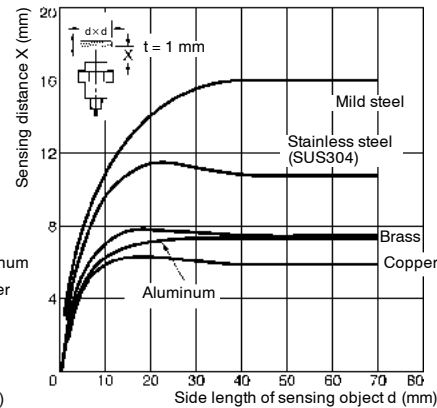

E2EM-X30MX□

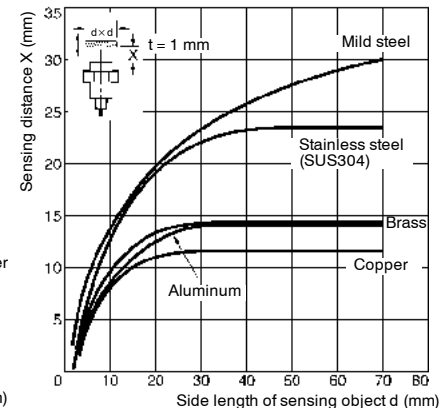

RESIDUAL VOLTAGE CHARACTERISTICS

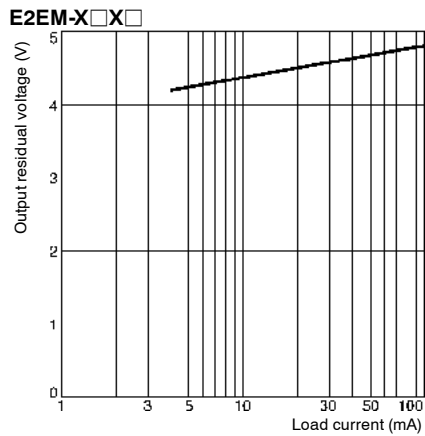

Operation

OUTPUT CIRCUITS

E2EM-X□X□ DC 2-wire Models

Operation	Model	Timing chart	Output circuit
NO	E2EM-X4X1 E2EM-X8X1 E2EM-X15X1 E2EM-X16MX1 E2EM-X30MX1		
NC	E2EM-X4X2 E2EM-X8X2 E2EM-X15X2 E2EM-X16MX2 E2EM-X30MX2		<p>Note: 1. The load can be connected to either +V or 0 V line. 2. There is no polarity.</p>

E2EM-X□B□/C□(-M1) DC 3-wire Models

Operation	Output specifications	Model	Timing chart	Output circuit
NO	NPN open collector output	E2EM-X2C1 (-M1) E2EM-X4C1 (-M1) E2EM-X8C1 (-M1) E2EM-X15C1 (-M1)	Sensing object: Yes (High), No (Low) Operation indicator (yellow): ON (High), OFF (Low) Control output: ON (High), OFF (Low)	<p>Note: Pin 4 is NO and Pin 2 is NC.</p>
		E2EM-X2C2 E2EM-X4C2 E2EM-X8C2 E2EM-X15C2	Sensing object: Yes (High), No (Low) Operation indicator (yellow): ON (High), OFF (Low) Control output: ON (High), OFF (Low)	<p>Note: Pin 4 is NO and Pin 2 is NC.</p>
NO	PNP open collector output	E2EM-X2B1 (-M1) E2EM-X4B1 (-M1) E2EM-X8B1 (-M1) E2EM-X15B1 (-M1)	Sensing object: Yes (High), No (Low) Operation indicator (yellow): ON (High), OFF (Low) Control output: ON (High), OFF (Low)	<p>Note: Pin 4 is NO and Pin 2 is NC.</p>
		E2EM-X2B2 E2EM-X4B2 E2EM-X8B2 E2EM-X15B2	Sensing object: Yes (High), No (Low) Operation indicator (yellow): ON (High), OFF (Low) Control output: ON (High), OFF (Low)	<p>Note: Pin 4 is NO and Pin 2 is NC.</p>

E2EM-X□B□/C□-M1 DC 3-wire Models

Connector	Output configuration	Applicable models	Pin arrangement
M12	NO	E2EM-X□C1-M1	<p>Note: Terminal 2 is not used.</p>
		E2EM-X□B1-M1	<p>Note: Terminal 2 is not used.</p>
	NC	E2EM-X□C2-M1	<p>Note: Terminal 4 is not used.</p>
		E2EM-X□B2-M1	<p>Note: Terminal 4 is not used.</p>

Dimensions

Unit: mm (inch)

■ PREWIRED MODELS (SHIELDED)

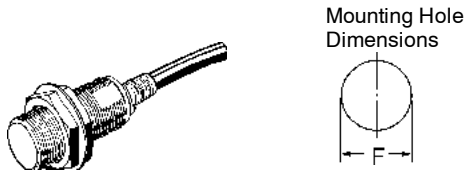

Outer diameter	M8	M12	M18	M30
F mm (in)	8.5 dia. +0.5/0 (0.33 dia. +0.02)	12.5 dia. +0.5/0 (0.49 dia. +0.02)	18.5 dia. +0.5/0 (0.73 dia. +0.02)	30.5 dia. +0.5/0 (1.2 dia. +0.02)

E2EM-X2B□/C□

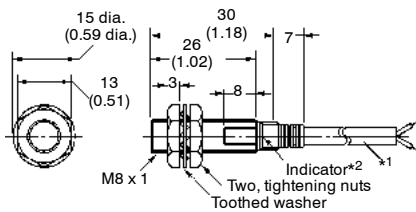

*1: Vinyl-insulated round cable (2 cores/3 cores), 4 dia. (60/0.08 dia.)
Standard length: 2 m (78.7 in)
Cable length (in single metal conduit): 200 m max.

*2: Operation indicator: yellow

E2EM-X4□□

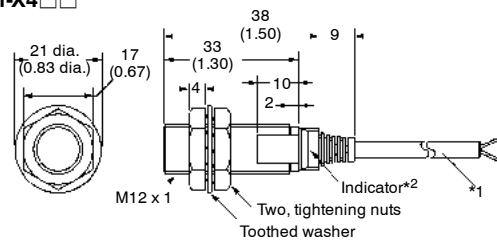

*1: Vinyl-insulated round cable (2 cores/3 cores), 4 dia.
Conductor cross-section: 0.3 mm²/insulator diameter: 1.3 mm
Standard length: 2 m (78.7 in)

*2: X1 models: Operation indicator: red, set indicator: green
X2 models: Operation indicator: red
B/C models: Operation indicator: yellow

E2EM-X8□□

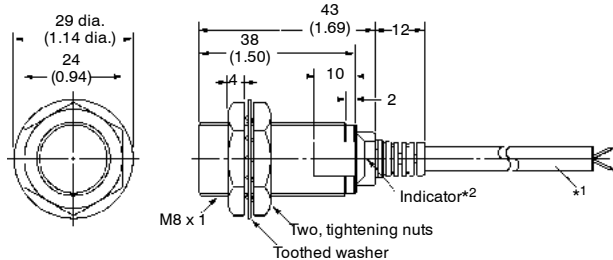

*1: Vinyl-insulated round cable (2 cores/3 cores), 6 dia.
Conductor cross-section: 0.5 mm²/insulator diameter: 1.9 mm
Standard length: 2 m (78.7 in)

*2: X1 models: Operation indicator: red, set indicator: green
X2 models: Operation indicator: red
B/C models: Operation indicator: yellow

E2EM-X15□□

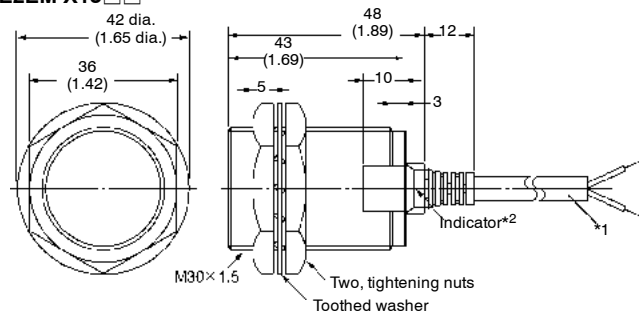

*1: Vinyl-insulated round cable (2 cores/3 cores), 6 dia.
Conductor cross-section: 0.5 mm²/insulator diameter: 1.9 mm
Standard length: 2 m (78.7 in)

*2: X1 models: Operation indicator: red, set indicator: green
X2 models: Operation indicator: red
B/C models: Operation indicator: yellow

PREWIRED MODELS (UNSHIELDED)

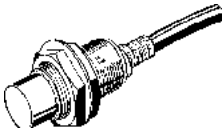

E2EM-X16MX□

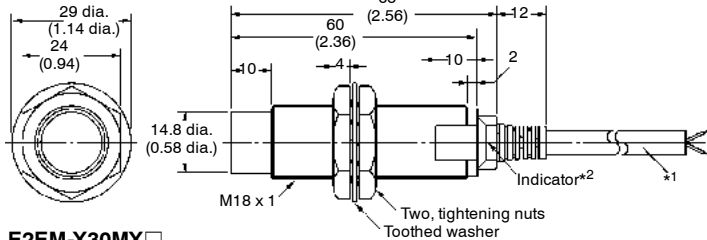

*1: Vinyl-insulated round cable (2 cores), 6 dia.
Conductor cross-section: 0.5 mm²/insulator diameter: 1.9 mm
Standard length: 2 m (78.7 in)

*2: X1 models: Operation indicator: red, set indicator: green
X2 models: Operation indicator: red

E2EM-X30MX□

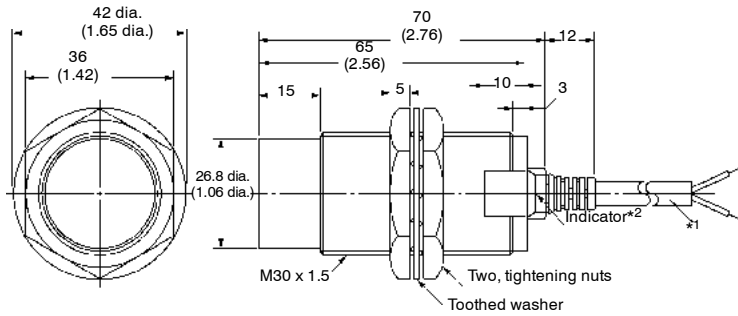

*1: Vinyl-insulated round cable (2 cores), 6 dia.
Conductor cross-section: 0.5 mm²/insulator diameter: 1.9 mm
Standard length: 2 m (78.7 in)

*2: X1 models: Operation indicator: red, set indicator: green
X2 models: Operation indicator: red

CONNECTOR MODELS (SHIELDED)

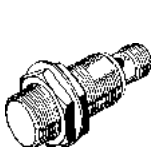

Mounting Hole Dimensions

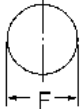

Outer diameter	M8	M12	M18	M30
F mm (in)	8.5 dia. +0.5/0 (0.33 dia. +0.02)	12.5 dia. +0.5/0 (0.49 dia. +0.02)	18.5 dia. +0.5/0 (0.73 dia. +0.02)	30.5 dia. +0.5/0 (1.2 dia. +0.02)

E2EM-X2B□/C□-M1

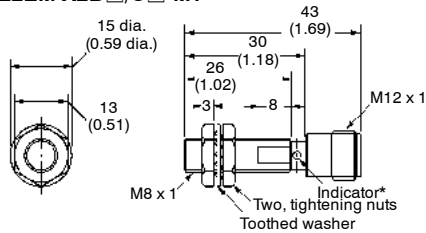

E2EM-X4B□/C□-M1

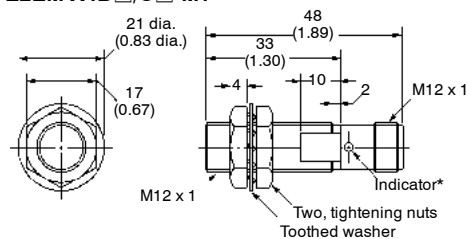

*Operation indicator: yellow

E2EM-X8B□/C□-M1

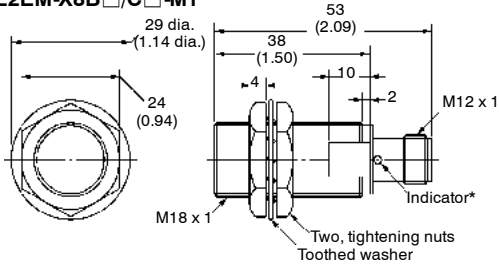

E2EM-X15B□/C□-M1

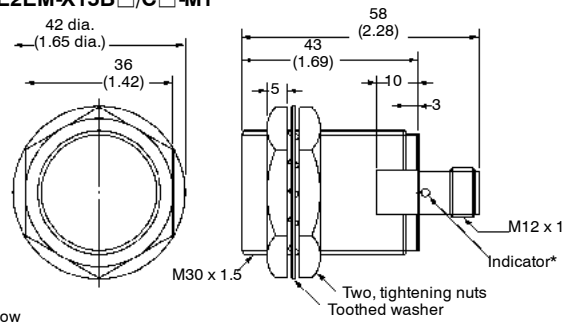

*Operation indicator: yellow

■ WHEN PROXIMITY SENSOR IS CONNECTED TO SENSOR I/O CONNECTOR

Shielded
(Straight)

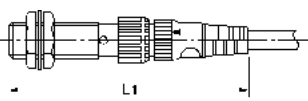

(L-shaped)

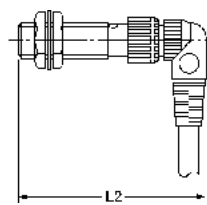

Unit: mm (inch)

Sensor diameter		L1	L2
M8		Approx. 75 (2.95)	Approx. 62 (2.44)
M12	DC	Approx. 80 (3.15)	Approx. 67 (2.63)
	AC	Approx. 85 (3.35)	Approx. 72 (2.83)
M18		Approx. 85 (3.35)	Approx. 72 (2.83)
M30		Approx. 90 (3.54)	Approx. 77 (3.03)

■ ACCESSORIES (ORDER SEPARATELY)

Mounting Brackets

Four kinds of resin mounting brackets are available. Choose an appropriate one depending on external dimensions

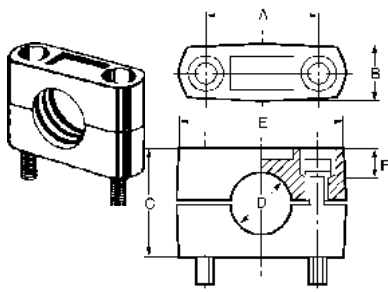

Part number	Dimensions mm (in)						Hexagonal bolts	Applicable Sensor outer diameter
	A	B	C	D	E	F		
Y92E-B8	18±0.2 (0.71 □0.01)	10 max.	18	8 dia. (0.31)	28 max.	6	M4 x 20	M8
Y92E-B12	24±0.2 (0.94 □0.01)	12.5 max.	20	12 dia. (0.47)	37 max.	6	M4 x 25	M12
Y92E-B18	32±0.2 (1.26 □0.01)	17 max.	30	18 dia. (0.71)	47 max.	7	M5 x 32	M18
Y92E-B30	45±0.2 (1.77 □0.01)	17 max.	50	30 dia. (1.18)	60 max.	10	M5 x 50	M30

Note: When using the Mounting Brackets for unshielded models, pay attention to the influence of surrounding metals. (For dimensions of Sensors, refer to the dimensions shown for each model.)

Installation

■ Connection with Sensor I/O Connectors

Proximity Sensors			Sensor I/O Connectors	Connection
Type	Operation	Part number		
DC 3-wire	NO	E2EM-X□C1-M1	1: Straight 2: L-shaped XS2F-D42□-□C0-A D: 2-m cable G: 5-m cable	
	NC	E2EM-X□C2-M1	1: Straight 2: L-shaped XS2F-D42□-□80-A D: 2-m cable G: 5-m cable	

Precautions

SAFETY PRECAUTIONS

Power Supply

Do not impose an excessive voltage on the E2EM, otherwise it may be damaged. Do not impose AC current (100 VAC) on any E2EM DC model, otherwise it may be damaged.

Load Short-circuit

Do not short-circuit the load, or the E2EM may be damaged.

The E2EM's short-circuit protection function will be valid if the polarity of the supply voltage imposed is correct and within the rated voltage range.

Wiring

Be sure to wire the E2EM and load correctly, otherwise it may be damaged.

Connection with No Load

Be sure to insert loads when wiring. Make sure to connect a proper load to the E2EM in operation, otherwise it may damage internal elements.

Do not expose the product to flammable or explosive gases.

Do not disassemble, repair, or modify the product.

CORRECT USE

Designing

Power Reset Time

The Proximity Sensor is ready to operate within 100 ms after power is supplied. If power supplies are connected to the Proximity Sensor and load respectively, be sure to supply power to the Proximity Sensor before supplying power to the load.

Effects of Surrounding Metal

When mounting the E2EM within a metal panel, ensure that the clearances given in the following table are maintained.

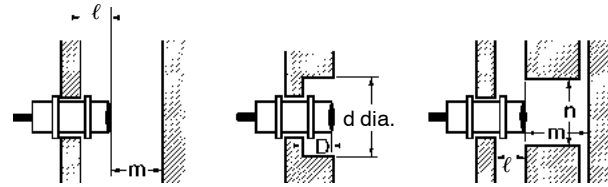

(Unit: mm) See note.

Type		Item	M8	M12	M18	M30
E2EM-X□X□ DC 2-wire	Shielded	ℓ	---	2.4	3.6	6
		d		18	27	45
		D		2.4	3.6	6
		m		12	24	45
		n		18	27	45
	Unshielded	ℓ	---	---	25	45
		d			70	120
		D			25	45
		m			48	90
		n			70	120
E2EM-X□B□/C□ DC 3-wire	Shielded	ℓ	0	2.4	3.6	6
		d	8	18	27	45
		D	0	2.4	3.6	6
		m	4.5	12	24	45
		n	12	18	27	45

Note: To convert mm to inches, multiply mm's by 0.03937.

Power OFF

The Proximity Sensor may output a pulse signal when it is turned OFF. Therefore, it is recommended that the load be turned OFF before turning OFF the Proximity Sensor.

Power Supply Transformer

When using a DC power supply, make sure that the DC power supply has an insulated transformer. Do not use a DC power supply with an auto-transformer.

AND/OR Connection

When using the product in an AND/OR circuit, the product may not function properly due to incorrect pulses or leakage currents. Therefore, confirm that no problems will occur before actually using the product in such a circuit.

Mutual Interference

When installing two or more Sensors face-to-face or side-by-side, ensure that the minimum distances given in the following table are maintained.

(Unit: mm) See note.

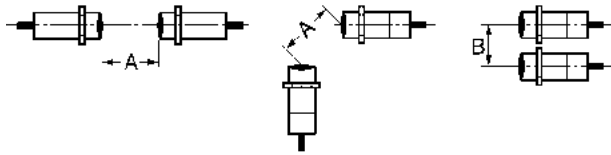

Type		Item	M8	M12	M18	M30
E2EM-X□X□ DC 2-wire	Shielded	A	---	30	60	110
		B		20	35	90
	Unshielded	A		---	200	350
		B			120	300
E2EM-X□B/C DC 3-wire	Shielded	A	20	30	60	110
		B	15	20	35	90

DESIGNING

Confirmation of Connection between DC 2-wire Proximity Sensor and Programmable Controller

Connection conditions are determined from the relationship between the input ON voltage and OFF voltage of the PC and the output residual voltage and leakage current of the Proximity Sensor.

Connection Conditions

1. Relationship between the ON voltage of the PC and the residual voltage of the Proximity Sensor must be as follows:

$$V_{on} \geq V_{cc} - V_R$$

V_{on} : ON voltage of the PC

V_{cc} : Supply voltage

V_R : Output residual voltage the Proximity Sensor

2. Relationship between the OFF voltage of the PC and the leakage current of the Proximity Sensor must be as follows:

$$V_{off} \geq I_{leak} \times R_{in}$$

V_{off} : OFF voltage of the PC

I_{leak} : Leakage current of the Proximity Sensor

R_{in} : Input impedance of the PC

Connection is possible under the following conditions.

Example values on the PC side

ON voltage: 10.2 V min.

OFF voltage: 3 V max.

Input impedance: 3.5 kΩ

Example values on the Proximity Sensor side

Output residual voltage: 5 V max.

Leakage current: 0.8 mA max.

If these values are put in the above formula, V_{on} and V_{off} will be as follows:

$$V_{on}: 10.2 \text{ V} < 24 \text{ V} - 5 \text{ V} (=19 \text{ V})$$

$$V_{off}: 3 \text{ V} > 0.8 \text{ mA} \times 3.5 \text{ k}\Omega (=2.8 \text{ V})$$

WIRING

High-tension Lines

Wiring through Metal Conduit:

If there is a power or high-tension line near the cable of the Proximity Sensor, wire the cable through an independent metal conduit to prevent against Proximity Sensor damage or malfunctioning.

Connections

DC 2-wire Models

Connection to relay load

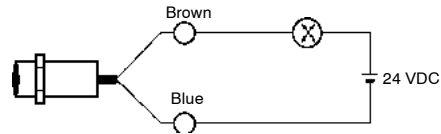

Note: The residual voltage of the DC 2-wire model is 5 V. Check the operating voltage of the relay.

Cable Extension

Cable length must be less than 200 m (656 ft.).

The tractive force is 50 N (11.24 lbF).

DC 3-wire Models

Connection to S3D2 Sensor Controller

Operation can be reversed by selecting the signal input selector of the S3D2.

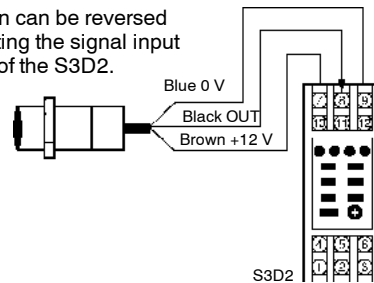

MOUNTING

The Proximity Sensor must not be subjected to excessive shock with a hammer when it is installed, otherwise the Proximity Sensor may be damaged or lose its water-resistivity.

Do not tighten the nut with excessive force. A washer must be used with the nut.

Type	Torque
M8	9 N • m (79.6 in lbF)
M12	30 N • m (265 in lbF)
M18	70 N • m (619 in lbF)
M30	180 N • m (1593 in lbF)

■ MAINTENANCE AND INSPECTION

Periodically perform the following checks to ensure stable operation of the Proximity Sensor over a long period of time.

1. Check for mounting position, dislocation, looseness, or distortion of the Proximity Sensor and sensing objects.
2. Check for loose wiring and connections, improper contacts, and line breakage.
3. Check for attachment or accumulation of metal powder or dust.
4. Check for abnormal temperature conditions and other environmental conditions.
5. Check for proper lighting of indicators (for models with a set indicator.)

Never disassemble or repair the Sensor.

■ ENVIRONMENT

Water Resistance

Do not use the Proximity Sensor underwater, outdoors, or in the rain.

Operating Environment

Be sure to use the Proximity Sensor within its operating ambient temperature range and do not use the Proximity Sensor outdoors so that its reliability and life expectancy can be maintained. Although the Proximity Sensor is water resistive, a cover to protect the Proximity Sensor from water or water-soluble machining oil is recommended so that its reliability and life expectancy can be maintained.

Do not use the Proximity Sensor in an environment with chemical gas (e.g., strong alkaline or acid gasses including nitric, chromic, and concentrated sulfuric acid gases).

■ CONNECTING LOAD TO DC 2-WIRE SENSOR

Refer to the following before using DC 2-wire Proximity Sensors.

Surge Protection

Although the Proximity Sensor has a surge absorption circuit, if there is any machine that has a large surge current (e.g., a motor or welding machine) near the Proximity Sensor, connect a surge suppressor to the machine.

Countermeasures Against Leakage Current

Connect a bleeder resistor as the bypass for the leakage current so that the current flowing into the load will be less than the load reset current.

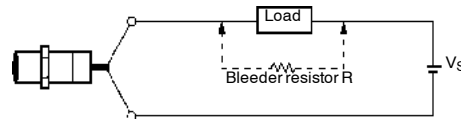

Refer to the following to calculate the bleeder resistance and the allowable power of the bleeder resistor.

Leakage Current

When the Proximity Sensor is OFF, the Proximity Sensor has leakage current. In this case, the load is imposed with a small voltage and the load may not be reset. Before using the Proximity Sensor, make sure that this voltage is less than the load reset voltage.

$$R \cong V_S / (i_R - i_{OFF}) \text{ (k}\Omega\text{)}$$

$$P > V_S^2 / R \text{ (mW)}$$

P: The allowable power of the bleeder resistor. (The actual power capacity of the bleeder resistor must be at least a few times larger than the allowable power of the bleeder resistor.)

i_R : Leakage current of the Proximity Sensor (mA)

i_{OFF} : Load reset current (mA)

It is recommended that 15 k Ω max./450 mW min. for 12 VDC and 30 k Ω max./0.1 W min. for 24 VDC be used.

Inrush Current

A load that has a large inrush current (e.g., a lamp or motor) will damage the Proximity Sensor, in which case connect the load to the Proximity Sensor through a relay.

NOTE: DIMENSIONS SHOWN ARE IN MILLIMETERS. To convert millimeters to inches divide by 25.4.

OMRON[®]**OMRON ELECTRONICS LLC**One East Commerce Drive
Schaumburg, IL 60173**1-800-55-OMRON****OMRON ON-LINE**Global - <http://www.omron.com>USA - <http://www.omron.com/oei>Canada - <http://www.omron.com/oci>**OMRON CANADA, INC.**885 Milner Avenue
Scarborough, Ontario M1B 5V8**416-286-6465**